



HEAVY DUTY LOADER



ASSEMBLY and OPERATING *Instructions*

DEARBORN MOTORS CORPORATION — DETROIT 3, MICHIGAN

DESCRIPTION OF HEAVY DUTY LOADER

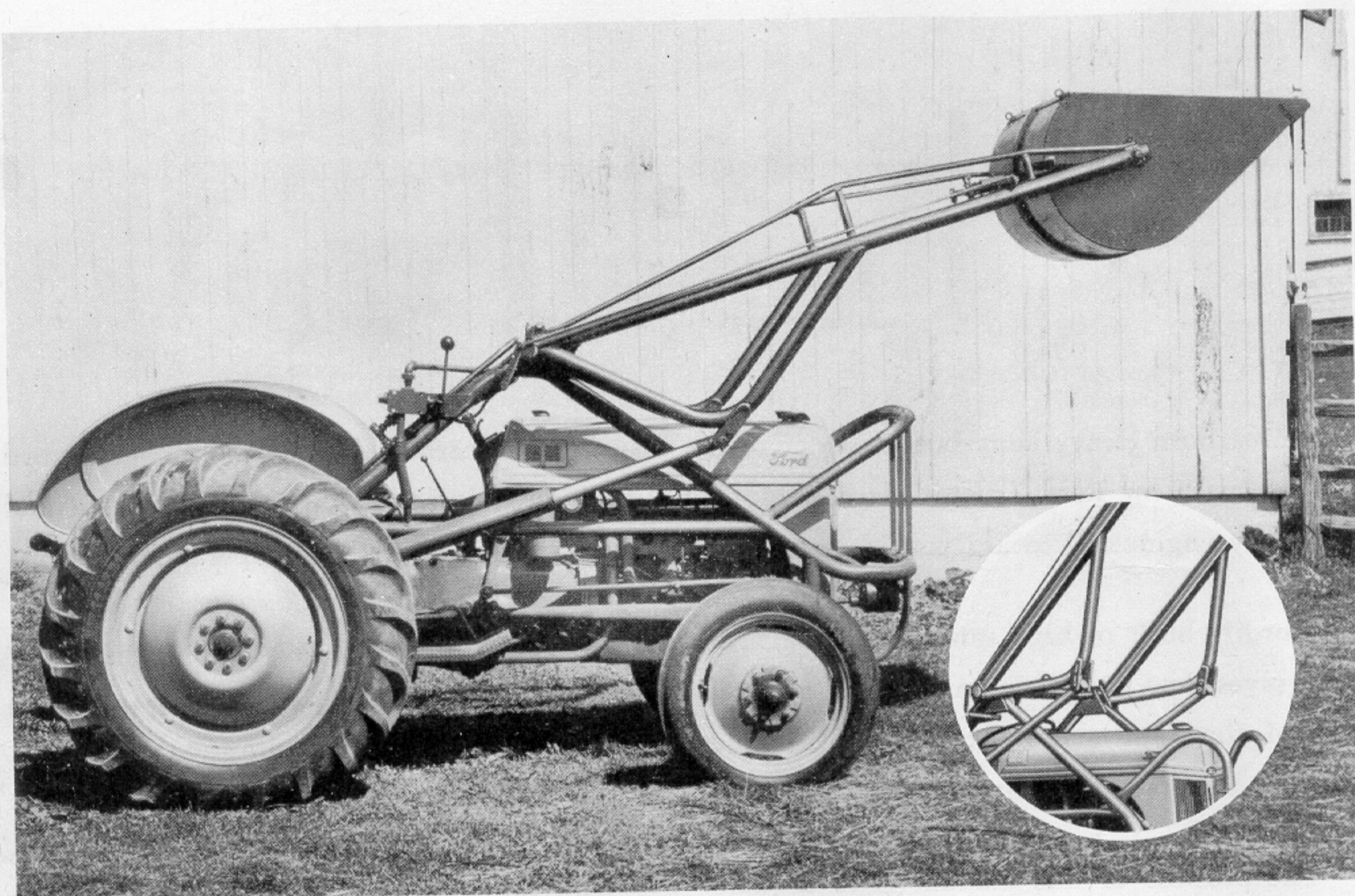

Figure 1

The Dearborn Heavy Duty Loader, pictured above, is mounted so that it "sits" on the Ford Tractor. It is attached to the rear axle housing and front mounting plate.

The loader is a complete unit in itself. The hydraulic system, consisting of an oil reservoir, a pump, oil lines and control lever and valve is a part of the loader. A portion of the sturdy tubular frame is used as an oil reservoir. The low pressure gear pump is driven by a splined shaft that is connected to the crankshaft of the tractor by means of a splined adapter which replaces the crankshaft pulley. The hydraulic system of the loader is free and separate from the Ford Tractor Hydraulic system.

Constructed to do heavy loading jobs, this implement is ideal for construction work, and for use in factories, coal and lumber yards. On a farm it is invaluable for such jobs as loading sand, gravel, corn, grain, sugar beets and manure.

NOTE: Loaders are shipped with Steel I-Beam or tubular construction. Performance and quality are identical.

ASSEMBLY OF THE LOADER

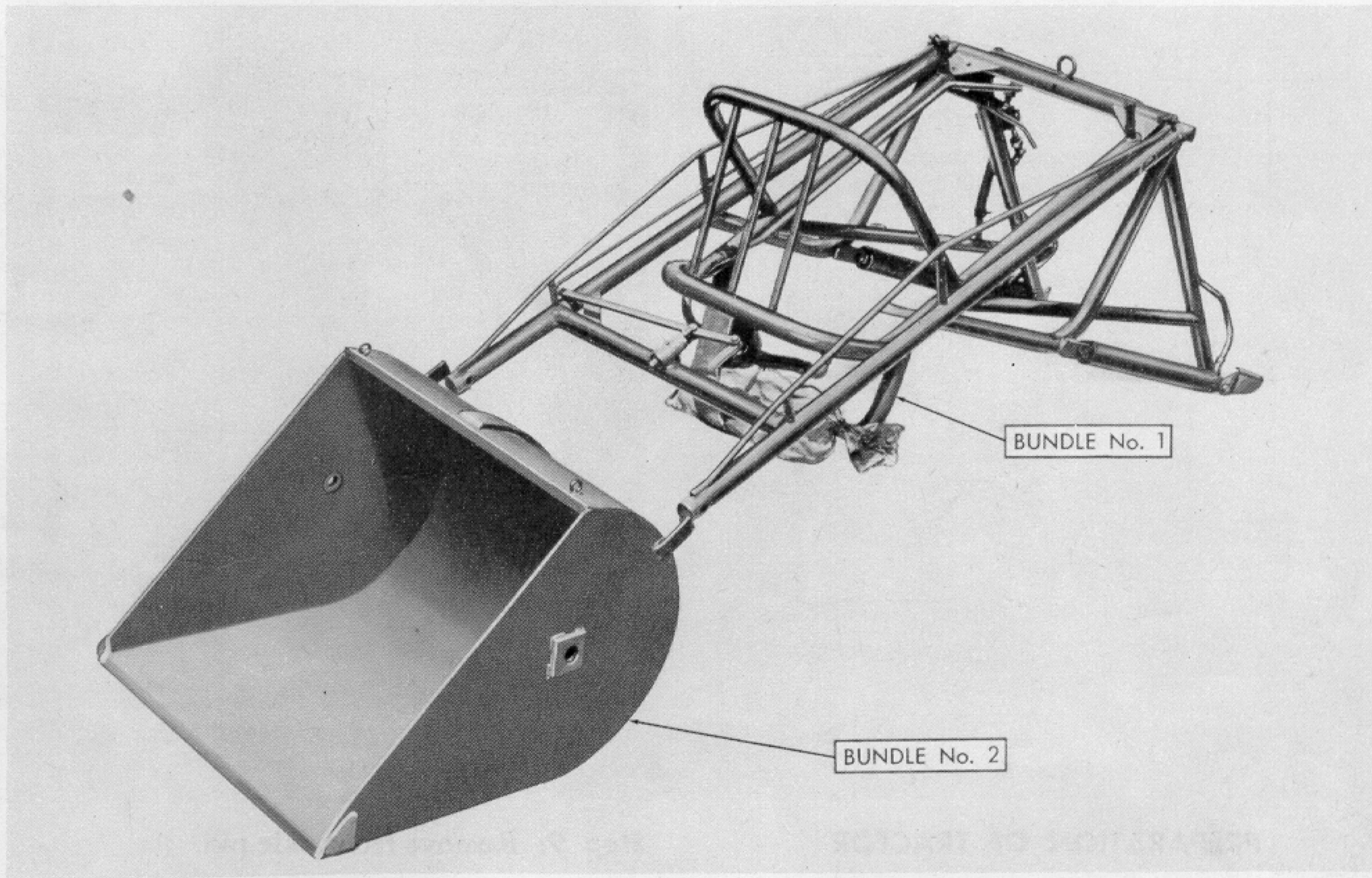

Figure 2

The Dearborn Heavy Duty Loader is shipped from the factory complete in one bundle with the front mounting plate, nuts and bolts in a sack wired to the frame of the loader. Normally, the scoop attachment accompanies the loader unless otherwise ordered by the Ford Tractor dealer.

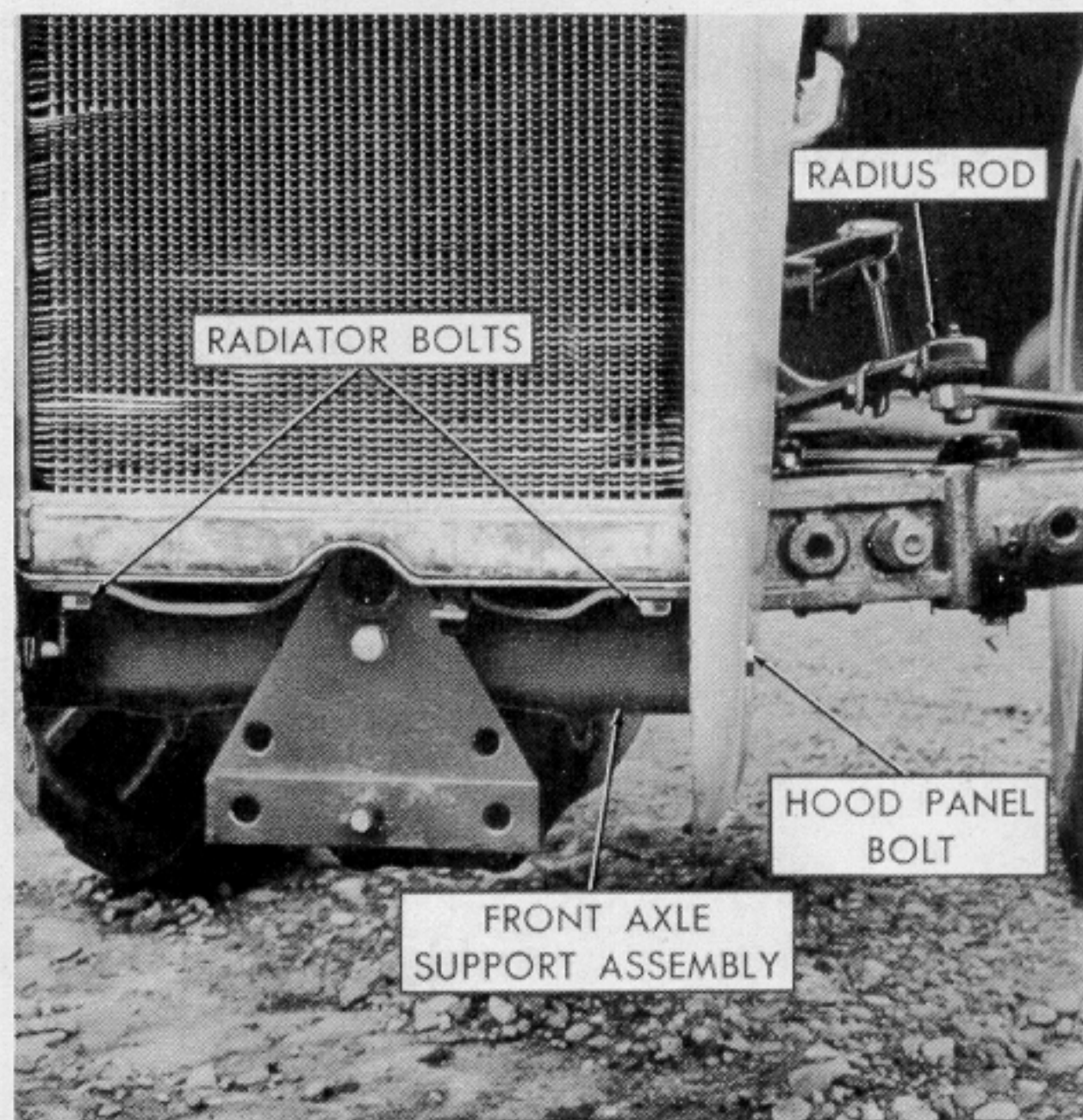

Figure 3

ATTACHING THE LOADER TO TRACTOR

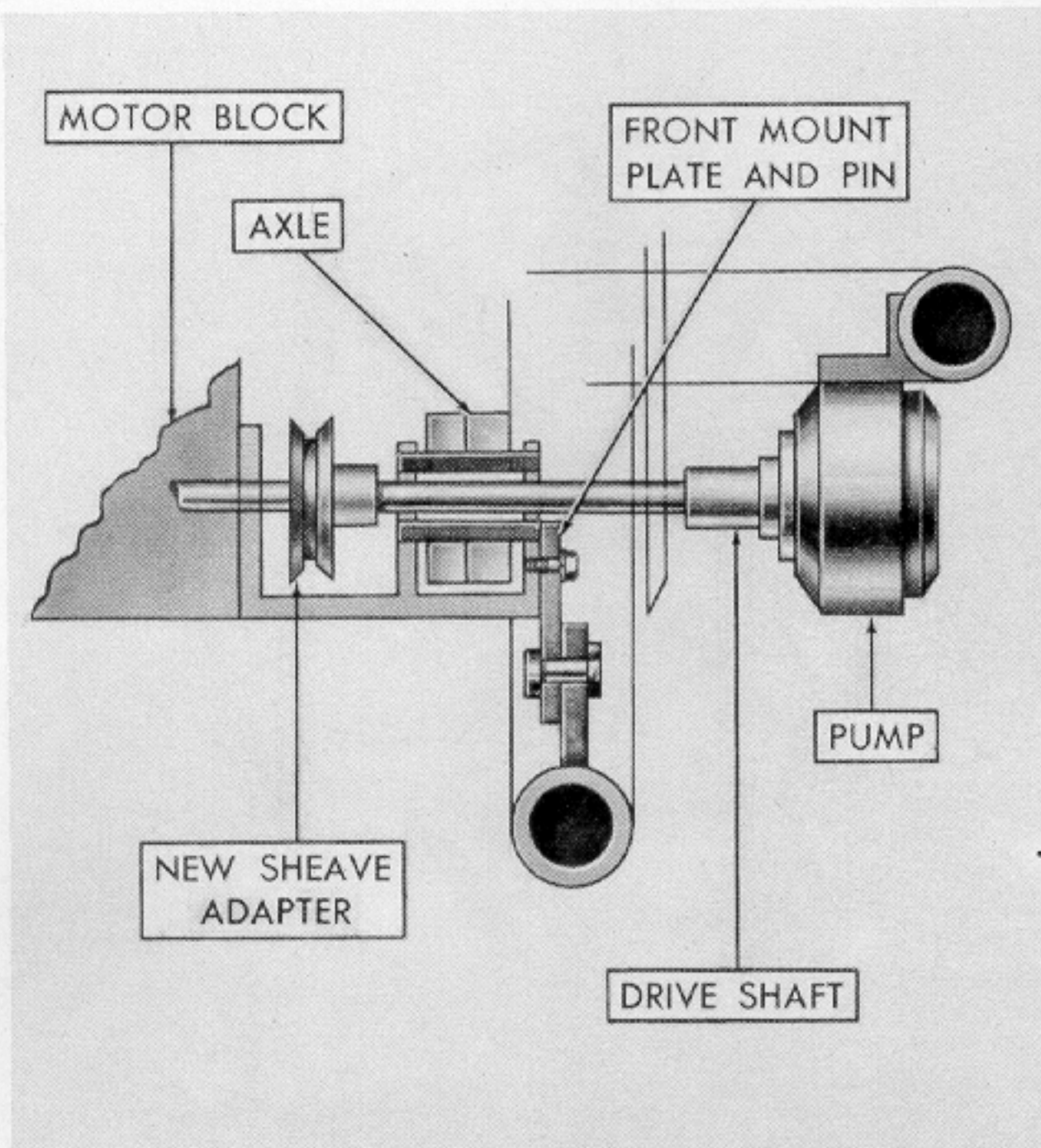

Figure 4

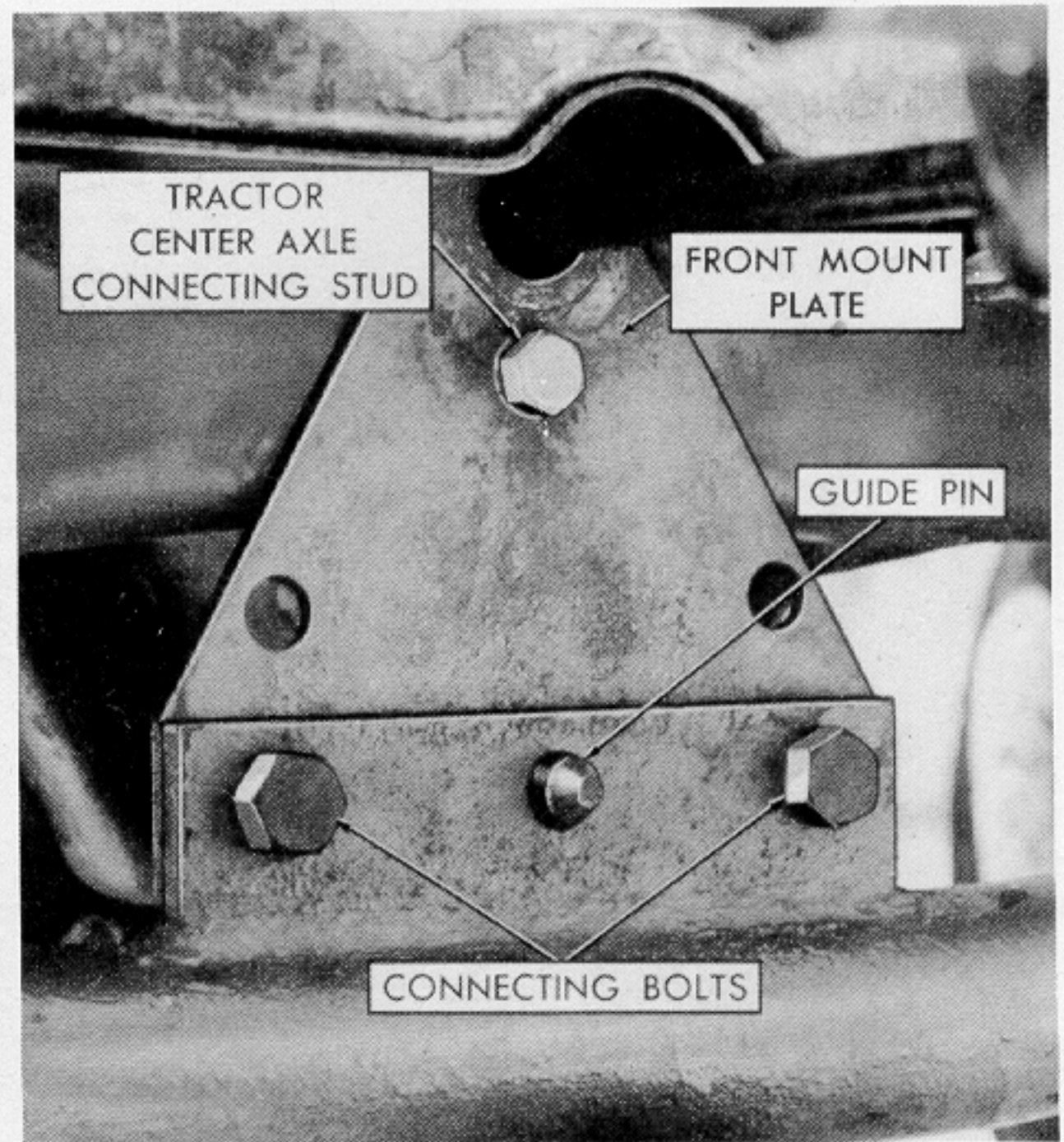

Figure 5

PREPARATION OF TRACTOR

- Step 1:** Remove both fenders.
- Step 2:** Place jack under crankcase and raise front wheels until free.
- Step 3:** Remove pins attaching right and left radius rods to front axle and free forward end of radius rods from axle.
- Step 4:** Remove radiator grille.
- Step 5:** Free right and left hand hood panels from front axle support assembly by removing bolts.
- Step 6:** Remove cap screw holding tractor front axle pin to front axle support assembly.
- Step 7:** Remove bolts that hold radiator to front axle support assembly so that radiator can be raised.
- Step 8:** Remove bolts from crankcase to free front axle support assembly.

Step 9: Remove front axle pin.

Step 10: Remove fan belt from crankshaft pulley.

Step 11: Loosen crank ratchet and remove from end of crankshaft.

Step 12: Remove crankshaft pulley.

ATTACHING FRONT ASSEMBLY

- Step 1:** Install new sheave adapter on crankshaft and secure with cap screw and lock washer.
- Step 2:** Replace fan belt on new sheave adapter.
- Step 3:** Install the new front axle pin by lining up the front axle support assembly and front axle assembly. Be sure the heavy washer is in the front of the front axle and three flat washers are back of it.

ATTACHING THE LOADER TO TRACTOR



Figure 6

Step 4: Bolt front axle support assembly to crankcase.

Step 5: Bolt the loader front mounting plate with pin to the front axle support assembly.

Step 6: Bolt front axle support assembly to radiator.

Step 7: Replace right hand and left hand radiator panel bolts.

Step 8: Replace radiator grille.

Step 9: Re-connect both radius rods to front axle assembly.

Step 10: Remove jack from under tractor.

Step 11: Insert loader pump driveshaft through front axle pin to crankshaft.

The tractor is now ready to receive the main frame of the loader.

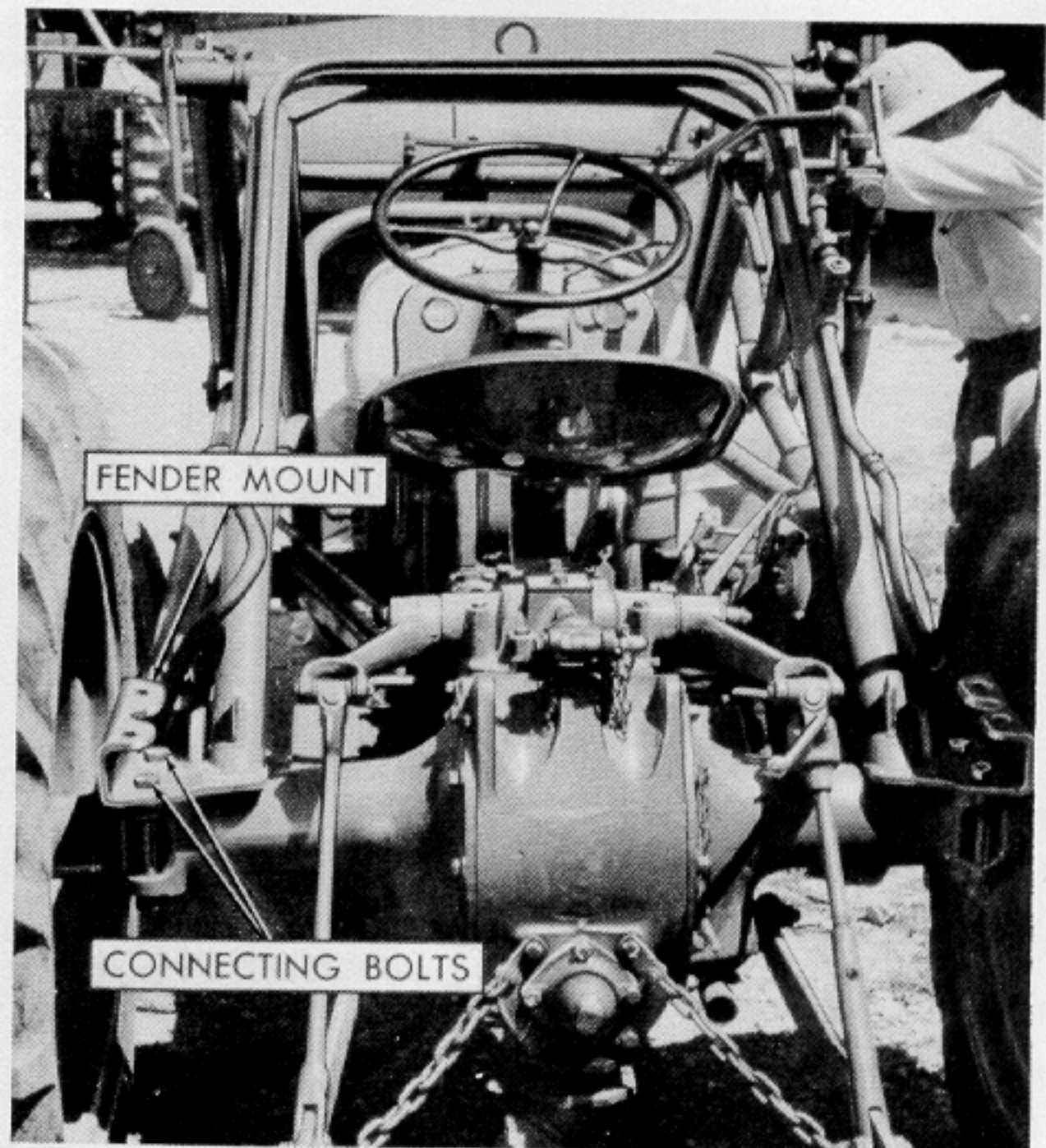

Figure 7

ATTACHING THE LOADER TO TRACTOR

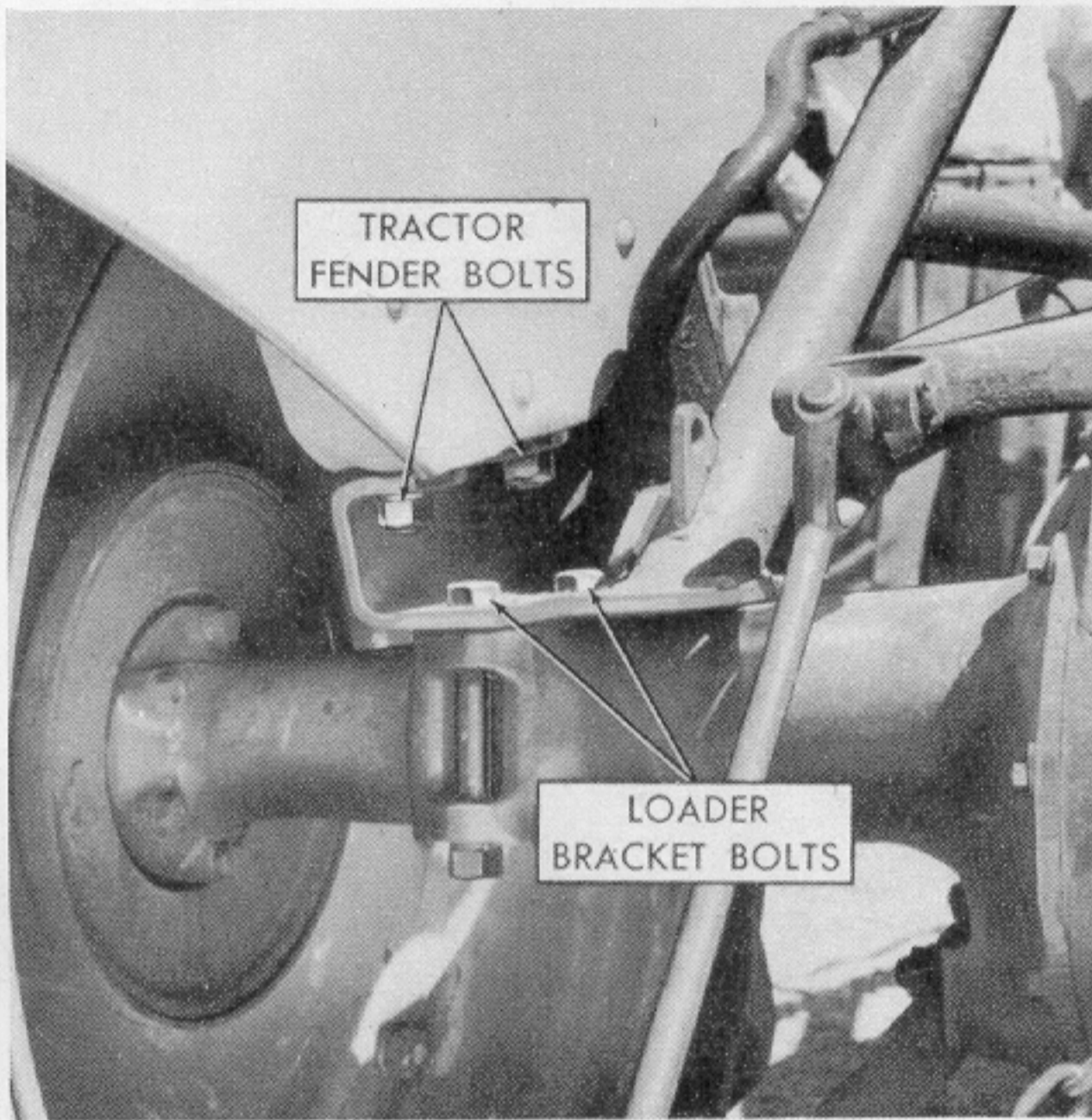

Figure 8

Step 1: Loosen the two bolts holding loader pump. This will permit alignment when splined pump shaft is installed in pump.

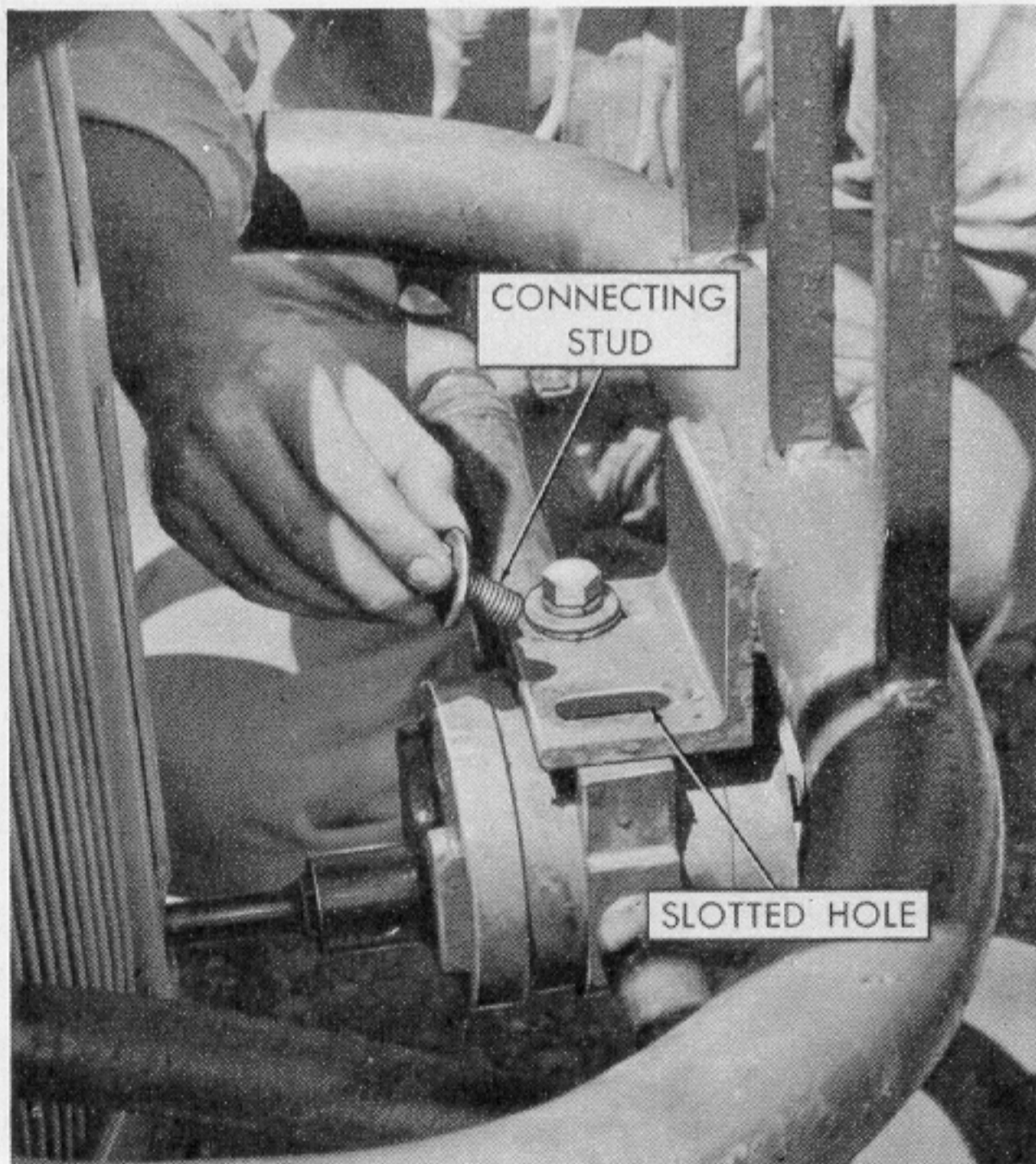

Figure 9

Step 2: Raise loader frame by means of lift hoist or block and tackle to height which approximates position on tractor. Block up front of frame to facilitate centering and attaching loader front mounting plate to tractor front mounting plate.

Step 3: Roll tractor into loader frame, as shown above.

Step 4: Position loader frame by lining up the guide pin on front mounting plate with center hole in plate on front of loader frame. Move tractor forward until guide pin extends through front mounting plate on loader frame.

CAUTION: Be sure pump shaft is in line with pump spline to avoid damage to shaft.

Step 5: Bolt loader front mounting plate to tractor front mounting plate.

Step 6: Bolt frame to rear axle housing, as shown in picture above.

Step 7: Insert splined shaft in pump.

Step 8: Adjust pump so that splined shaft has approximately $\frac{1}{8}$ inch end play.

NOTE: In adjusting pump, make sure alignment is correct. Pump may be aligned with crankshaft by moving pump forward or backward in slotted holes. It may be aligned in vertical plane by the use of small shims under the pump mounting plate.

Step 9: Bolt fenders to upper flange on loader frame with fender bolts, as shown in picture above.

Step 10: Attach scoop to the frame with a pin on either side and secure with cotter pins.

OPERATING THE LOADER



Figure 10

The Dearborn Heavy Duty Loader is invaluable for loading about the farm or on construc-

tion jobs. For example, it will replace an entire crew of men engaged in such work as loading gravel or sand into trucks. The loader may also be used to load corn, grain, and sugar beets. Likewise, it may be used to load manure into a spreader.

The loader is valuable in making excavations of all kinds, provided the top soil is first broken. After the hard soil has been broken up, it can be loaded rapidly into trucks.

In operating the loader, the bucket will dump better from the high position and reset better from the low position. The bucket is balanced to give a flowing dumping action which prevents damage to truck or wagon.

When it becomes necessary to lower a *loaded* bucket, do not stop the movement of the bucket suddenly. Such action will place an excessive strain on the tractor. There is little chance of damaging the loader itself, but it should be operated in a manner that will not damage the tractor.

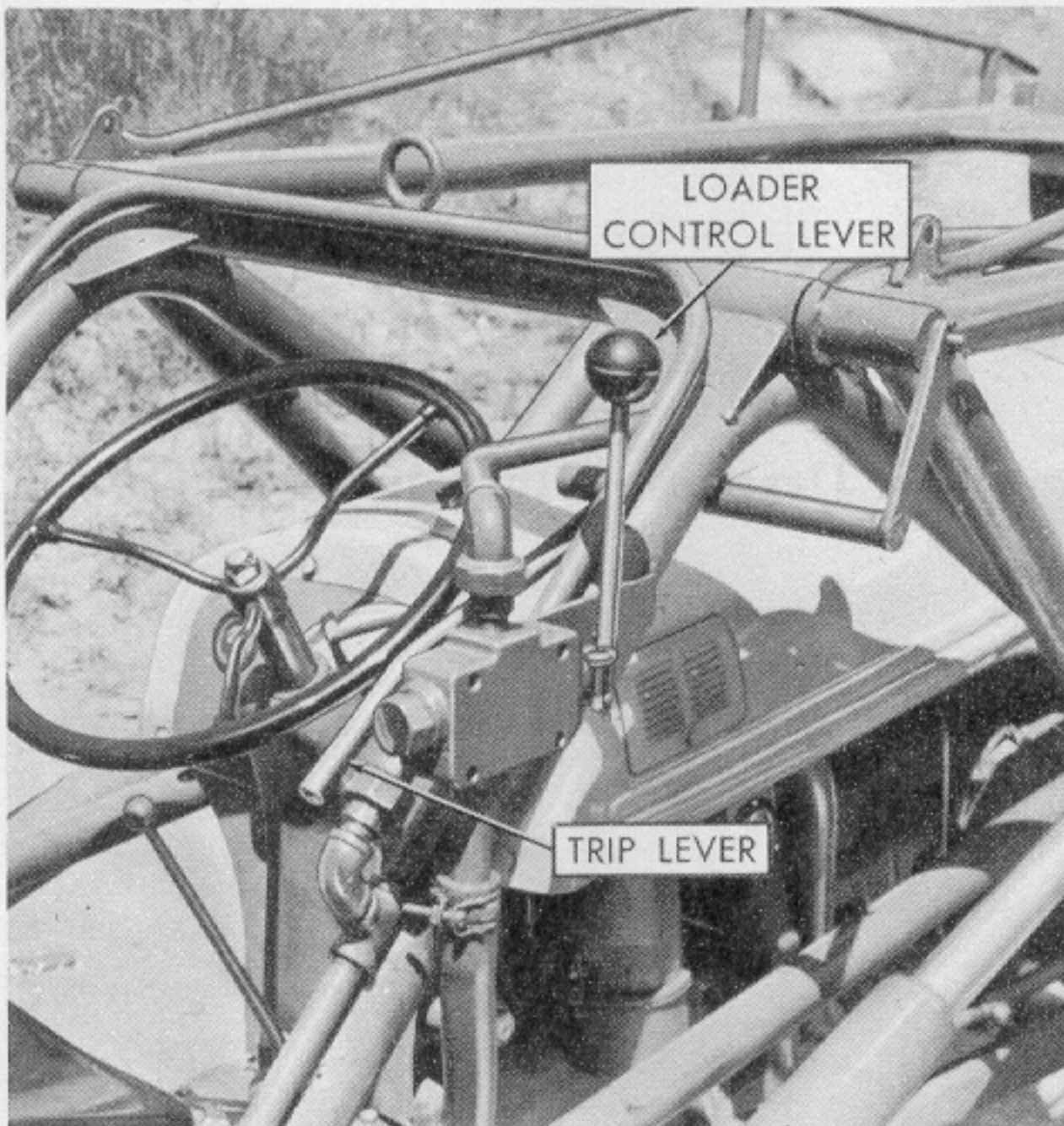

Figure 11

LUBRICATION

There are six zerck fittings on the Heavy Duty Loader. One is located on the bucket lock pin sleeve, one on each hydraulic lift point, the fourth is on the loader pivot cross member, and one at rear end of each hydraulic lift arm just above rear axle.

MAINTENANCE

1. Clean loader after each use and cover bucket surfaces with a good grade of rust preventive.
2. Store loader in a clean, dry place on wood or cement floor, if possible.
3. Use touch-up paint as necessary to prevent rust and maintain appearance of implement.
4. Keep oil reservoir filled to top of filler plug.
5. Keep all nuts tight.
6. Replace worn parts promptly, using only genuine Dearborn Farm Equipment Repair Parts.